

Item L7819R

Cover Plate

IP20



DESCRIPTION

A timeless Palagi socket plate for interior, efficient concept. Seamless, very compact minimal design, available on different materials and finishes, personalising every place on board. A wide selection of function modules is available.

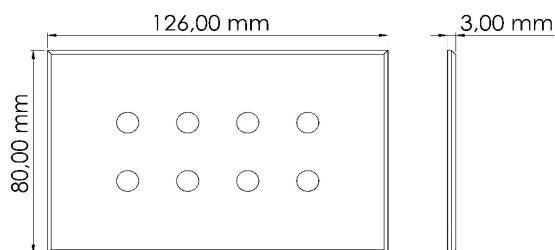

Material Finish:

STAINLESS STEEL, BRASS

Trim Ring Finish:

POLISHED, BRUSHED, BURNISHED, ANY COLOUR

Socket Type:

8 SWITCHES BUTTONS
PUSH BUTTON (16A)
OR
SWITCH(16A)

Mounting Method:

PALAGI FRAME +
PALAGI HOUSING
H004 (HOLLOW WALLS)
OR
504E (MASONRY)

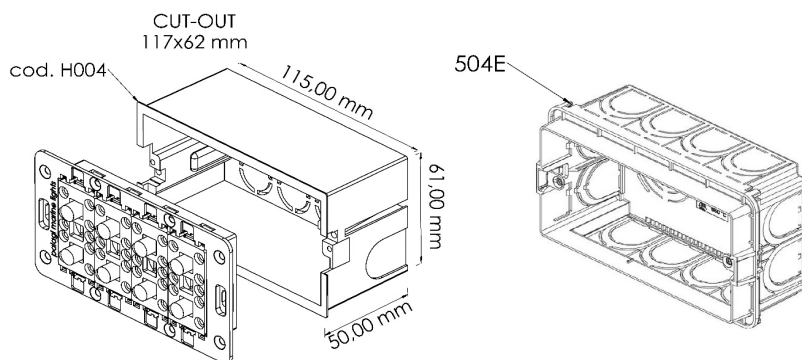

Information provided with this may be subjected to change any time without notice

